

OWNERS MANUAL



Intended to alert the user to the presence of uninsulated "dangerous voltage" within the product's enclosure that may be of sufficient magnitude to constitute a risk of electric shock to persons.



Intended to alert the user to the presence of important operating and maintenance (servicing) instructions in the literature accompanying the product.

CAUTION: Risks of electrical shock — DO NOT OPEN

CAUTION: To reduce the risk of electric shock, do not remove cover. No user serviceable parts inside. Refer Servicing to qualified service personnel.



UNITY™ 1000 SM



WARNING: TO PREVENT ELECTRICAL SHOCK OR FIRE HAZARD, DO NOT EXPOSE THIS APPLIANCE TO RAIN OR MOISTURE. BEFORE USING THIS APPLIANCE, READ THE OPERATING GUIDE FOR FURTHER WARNINGS.

UNITY™ 1000 SM

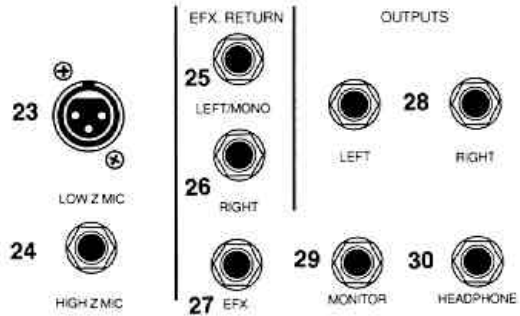
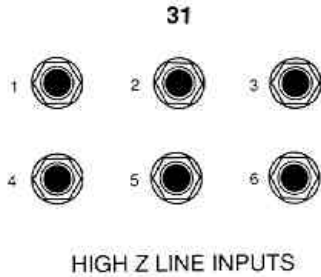

UNITY™ SERIES
1000 SM

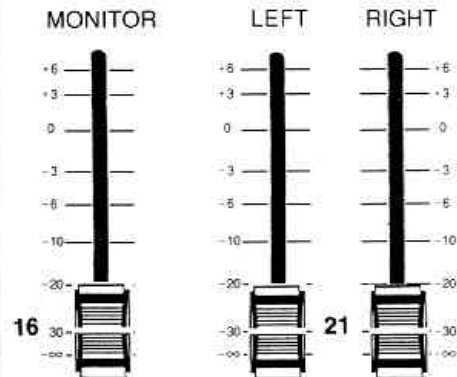
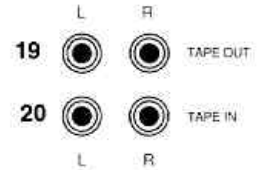
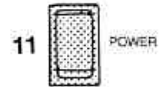
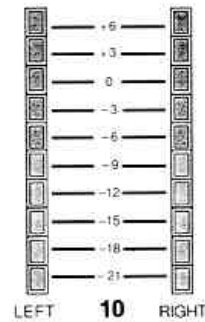
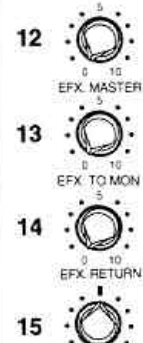
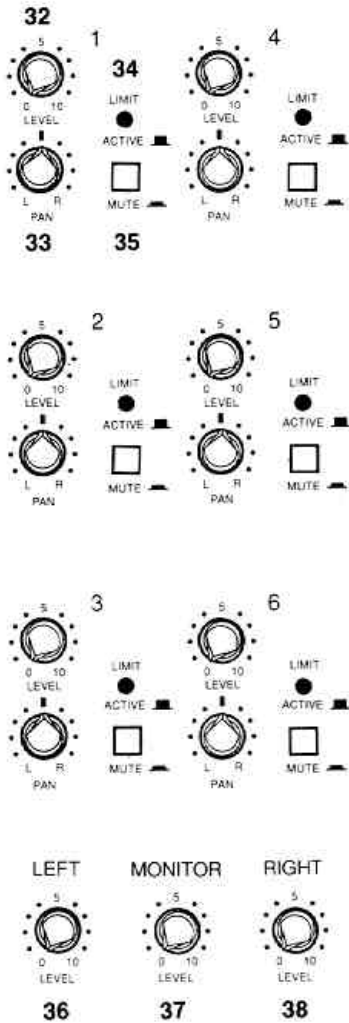

SUB MIX MATRIX

UNITY™ 1000 SM

GAIN (1)

Varies the gain of the channel input stage to allow a wide input dynamic range. Proper adjustment of the input gain is aided by observance of the LIMIT LED.

HIGH (2)

An active tone control (shelving type, ± 15 dB) that varies the high frequency range.

MID (3)

An active control capable of 15 dB boost or cut at 600 Hz.

LOW (4)

An active tone control (shelving type, ± 15 dB) that varies the low frequency boost or cut.

MONITOR SEND (5)

Controls the channel Monitor mix level. The signal from this control is "post" EQ, and "pre" fader allowing channel fader adjustment without affecting the Monitor mix.

EFFECTS SEND (6)

Controls the channel Effects mix level. This control regulates the amount of signal routed to the Effects master. Post fader.

PAN (7)

For stereo operation, PAN is used to assign channel output to Left, Right, or in between. For mono operation, Channel is assigned to either Right or Left master.

LIMIT LED (8)

Indicates when the signal level in the channel is too high. It illuminates when the channel signal reaches approximately +12 dBV.

CHANNEL LEVEL FADER (9)

Determines the level of the channel in the left and right mixes. Calibration is in dB and level is variable from - infinity (off) to +6 dB. This control should be operated near the "0 dB" (unity gain) indicator whenever possible to assure an optimum balance between channel noise and headroom.

LED ARRAYS (10)

Two 10 segment, LED arrays are provided to visually indicate the levels of the left and right mixes selected.

POWER SWITCH (11)

Depress to "On" position to turn on.

EFX. MASTER (12)

Determines the overall effects level supplied to the Effects output jack.

EFX. TO MONITOR (13)

Allows the Effects return to be assigned to Monitor.

EFX. RETURN (14)

When an outboard effects device is connected into the Effects patch loop, this control regulates the level of the effect in the Left or Right mix. Must be used together with the Effects Pan.

EFFECTS PAN (15)

Allows the Effects return signal to be assigned to Left Main, Right Main, or both.

MONITOR FADER (16)

Determines the overall signal level at the Monitor output jack.

TAPE OUT LEVEL (17)

Controls Stereo signal level at Tape Output jacks. Signal level at this point is independent of Left and Right master faders.

TAPE IN LEVEL (18)

Controls level of signals patched in at Tape Input jacks.

TAPE OUT JACKS (19)

Provides Stereo signal to be supplied to Left and Right inputs of stereo tape deck.

TAPE IN JACKS (20)

Provides Stereo inputs for signal supplied by Left and Right outputs of stereo tape deck, or CD player.

LEFT/RIGHT (21)

These are the masters for all channels and determine the overall main or "house" mix levels.

HEADPHONE LEVEL (22)

Adjusts the left and right signal level to the headphone jack. Signal taken pre the left and right main faders.

LOW Z IN (23)

For use with low impedance microphones or low level sources equipped with an XLR connector.

HIGH Z IN (24)

For use with high impedance microphones or high level sources equipped with a 1/4" phone plug.

LEFT/MONO RETURN (25)

Mono Effects Devices connected to Effects loop may be returned at this point. This input supplies Mono signal to both Left and Right master outputs. When stereo Effects device is connected to Effects loop, the Left output from the Effects device should be patched in at this point. (See right return) (See stereo effects patch diagram)

RIGHT RETURN (26)

Use when "Stereo" Effects device is used. When Stereo Effects device is connected to Effects loop, the Right output from the Effects device should be patched in at this point. (See Left/Mono Return) (See stereo effects patch diagram)

EFX. A OUTPUT (27)

Output for supplying signals to external effects or signal processing equipment.

LEFT OUT/RIGHT OUT (28)

These outputs are from the Left and Right Mains and the levels are adjusted by the Left and Right controls.

MONITOR OUTPUT (29)

Provides the signal for an external monitor amplifier/speaker system. The level is determined by the channel monitor and master monitor controls.

HEADPHONE JACK (30)

This stereo jack allows signal to flow to both sides of any stereo headset. Tip = Left, Ring = Right.

HIGH Z LINE INPUT (31)

For use with high level sources equipped with a 1/4" phone plug.

LEVEL (32)

Varies the level of the sub mix channel. Proper adjustment of the input level is aided by observance of the limit LED.

PAN (33)

For stereo operation, Pan is used to assign sub mix channel output to left, right or in between. For mono operation, sub mix channel is assigned to either left or right master.

LIMIT LED (34)

Indicates when the signal level in the sub mix channel is too high. It illuminates when the sub mix channel signal reaches approximately +12 dBV.

MUTE (35)

Used to mute the sub mix channel. When the mute switch is in the down position the mute is active, therefore signals are disabled from left, right and monitor.

SUB MIX LEFT (36)

Determines the overall level of all the sub mixes in the left master.

SUB MIX MONITOR (37)

Determines the overall level of all the sub mixes in the monitor master.

SUB MIX RIGHT (38)

Determines the overall level of all the sub mixes in the right master.

UNITY™ 1000 SM SPECIFICATIONS

Summary of Functions:

Sub Mix Matrix:

6 unbalanced line level inputs with mute; limit LED; level control and pan. Overall level control for left, right, and monitor.

Main Channels:

12 low Z balanced mic inputs or 12 high Z unbalanced line inputs with gain control; 3 band EQ; monitor send; effect send; pan control; and 60 mm fader level control.

Master Section:

60 mm monitor fader, 60 mm main left and right faders; effects master with pan control; effects to monitor control, stereo effects return jack (left/mono and right) output for left, right, monitor, stereo headphone jack with level control; 2 LED arrays for left and right.

Sub Mix Channel Line Inputs:

Line Impedance: 100 K ohms unbalanced
Nominal Input Level: 0 dBV
1V RMS
Minimum Input Level: -24 dBV
60 mV RMS
Maximum Input Level: +13 dBV
4V RMS

Channel Microphone Inputs:

Mic Impedance: Low Z,
150-600 ohms balanced
Nominal Input Level: -30 dBV,
30 mV RMS

Minimum Input Level: -44 dBV,
6 mV RMS
Maximum Input Level: +6 dBV,
2V RMS

Channel Line Inputs:

Line Impedance: 40K ohms unbalanced
Nominal Input Level: -16 dBV,
160 mV RMS
Minimum Input Level: -30 dBV,
30 mV RMS
Maximum Input Level: +20 dBV,
10V RMS

Left, Right, Monitors & Effects Unbalanced Outputs:

Load Impedance: 600 ohms or greater
Nominal Output: 0 dBV, 1V RMS
Maximum Output: +18 dBV, 8V RMS
(50K ohms load)
+14 dBm,
4V RMS
(600 ohms load)

Left/Mono & Right Effects Return Inputs:

Line Impedance: 22K ohms unbalanced
Nominal Input Level: -3 dBV,
0.7V RMS
Minimum Input Level: -18 dBV,
130 mV RMS
Maximum Input Level: +6 dBV,
2V RMS

The following specs are measured with a nominal input gain setting of

5, all channel & master sliders set @ 0 dB, all EQ set flat, all low Z inputs terminated with 150 ohms

Frequency Response:

+0, -2 dB, 20 Hz to 30 kHz

Preamp Hum & Noise:

-83 dBV (high Z line inputs)
-76 dBV (low Z mic inputs)
(8 channel version, all channels on)

Equivalent Input Noise:

-116 dBV (150 ohm source)

Distortion:

Less than 0.02% THD (typically below .01%
(1V RMS output, 20 Hz to 20 kHz)

Equalization:

±15 dB @ 50 Hz & 10 kHz, shelving
±15 dB @ 600 Hz, peak/notch

Crosstalk:

Greater than 50 dB @ 1 kHz

Maximum Available Gain:

+6 dB - master slider; +6 dB - channel slider
+44 dB - input control (low Z);
+56 dB - total

Channel LED Level Indicator:

+12 dBV

Master LED Readout Range:

-21 dBV to +6 dBV (left, right, monitors)

Power Requirements:

120V AC, 60 Hz, 20 watts

DANGER

EXPOSURE TO EXTREMELY HIGH NOISE LEVELS MAY CAUSE A PERMANENT HEARING LOSS. INDIVIDUALS VARY CONSIDERABLY IN SUSCEPTIBILITY TO NOISE INDUCED HEARING LOSS. BUT NEARLY EVERYONE WILL LOSE SOME HEARING IF EXPOSED TO SUFFICIENTLY INTENSE NOISE FOR A SUFFICIENT TIME.

THE U.S. GOVERNMENT'S OCCUPATIONAL SAFETY AND HEALTH ADMINISTRATION (OSHA) HAS SPECIFIED THE FOLLOWING PERMISSIBLE NOISE LEVEL EXPOSURES:

DURATION PER DAY IN HOURS

8
6
4
3
2
1 1/2
1
1/2
or less

SOUND LEVEL (dBA, SLOW RESPONSE)

90
92
95
97
100
102
105
110
115

ACCORDING TO OSHA, ANY EXPOSURE IN EXCESS OF THE ABOVE PERMISSIBLE LIMITS COULD RESULT IN SOME HEARING LOSS.

EAR PLUGS OR PROTECTORS IN THE EAR CANALS OR OVER THE EARS MUST BE WORN WHEN OPERATING THIS AMPLIFICATION SYSTEM IN ORDER TO PREVENT A PERMANENT HEARING LOSS IF EXPOSURE IS IN EXCESS OF THE LIMITS AS SET FORTH ABOVE. TO INSURE AGAINST POTENTIALLY DANGEROUS EXPOSURE TO HIGH SOUND PRESSURE LEVELS, IT IS RECOMMENDED THAT ALL PERSONS EXPOSED TO EQUIPMENT CAPABLE OF PRODUCING HIGH SOUND PRESSURE LEVELS SUCH AS THIS AMPLIFICATION SYSTEM BE PROTECTED BY HEARING PROTECTORS WHILE THIS UNIT IS IN OPERATION.

CAUTION

THIS MIXING CONSOLE/EFFECTS DEVICE/PREAMP HAS BEEN DESIGNED AND CONSTRUCTED TO PROVIDE ADEQUATE SIGNAL (VOLTAGE) FOR PLAYING MODERN MUSIC. IMPROPER USE OF THE GAIN/EQUALIZER CONTROLS AND/OR IMPROPER USE OF INTERNAL/EXTERNAL BUSES MAY CREATE CLIPPING (SQUARE WAVES) AND POSSIBLY CAUSE SUBSEQUENT DAMAGE TO THE LOUSPEAKER SYSTEMS. EXTENDED OPERATION OF THE GAIN/EQUALIZATION CONTROLS IN THEIR MAXIMUM POSITION IS THEREFORE NOT RECOMMENDED. PLEASE BE AWARE THAT MAXIMUM POWER CAN BE OBTAINED WITH VERY LOW SETTINGS OF THE GAIN/EQUALIZATION CONTROLS IF THE INPUT SIGNAL IS VERY STRONG.

IT IS COMMON PRACTICE AMONG USERS OF SOUND REINFORCEMENT EQUIPMENT TO IDENTIFY THE INDIVIDUAL CHANNELS WITH A STRIP OF TAPE PLACED ABOVE OR BELOW THE ROW OF VOLUME FADERS. MANY TYPES OR BRANDS OF TAPE HAVE A VERY STRONG ADHESIVE WHICH CAN INHIBIT THE PAINT ON THE FACEPLATE AND ACTUALLY REMOVE THE PAINT WHEN THE TAPE IS REMOVED. WE STRONGLY RECOMMEND THAT SCOTCH TAPE NOT BE USED ON PAINTED SURFACES NOR ANY OTHER TAPE THAT IS NOT ESPECIALLY DESIGNED FOR SUCH APPLICATIONS. MEDIUM OR LIGHT ADHESIVE MASKING OR LABEL TAPE IS RECOMMENDED IF TAPE IS USED. ANY TAPE LEFT ON PAINTED SURFACE FOR EXTENDED PERIODS WILL BE DIFFICULT TO REMOVE. NEVER USE CLEAR OR SCOTCH TAPE FOR THESE APPLICATIONS.

1. Read all safety and operating instructions before using this product.
2. All safety and operating instructions should be retained for future reference.
3. Obey all cautions in the operating instructions and on the back of the unit.
4. All operating instructions should be followed.
5. This product should not be used near water, i.e. a bathtub, sink, swimming pool, wet basement, etc.
6. This product should be located so that its position does not interfere with its proper ventilation. It should not be placed flat against a wall or placed in a built-in enclosure that will impede the flow of cooling air.
7. This product should not be placed near a source of heat such as a stove, radiator or another heat producing amplifier.

8. Connect only to a power supply of the type marked on the unit adjacent to the power supply cord.
9. Never break off the ground pin on the power supply cord. For more information on grounding write for our free booklet "Shock Hazard and Grounding."
10. Power supply cords should always be handled carefully. Never walk or place equipment on power supply cords. Periodically check cords for cuts or signs of stress, especially at the plug and the point where the cord exits the unit.
11. The power supply cord should be unplugged when the unit is to be unused for long periods of time.
12. If this product is to be mounted in an equipment rack, rear support should be provided.

13. Metal parts can be cleaned with a damp rag. The vinyl covering used on some units can be cleaned with a damp rag, or an ammonia based household cleaner if necessary.
14. Care should be taken so that objects do not fall and liquids are not spilled into the unit through the ventilation holes or any other openings.
15. This unit should be checked by a qualified service technician if:
 - A. The power supply cord or plug has been damaged.
 - B. Anything has fallen or been spilled into the unit.
 - C. The unit does not operate correctly.
 - D. The unit has been dropped or the enclosure damaged.
16. The user should not attempt to service this equipment. All service work should be done by a qualified service technician.

SYSTEM PATCH

NOTE:
LOW AND
HIGH Z INPUTS
CAN NOT BE
USED AT THE
SAME TIME.

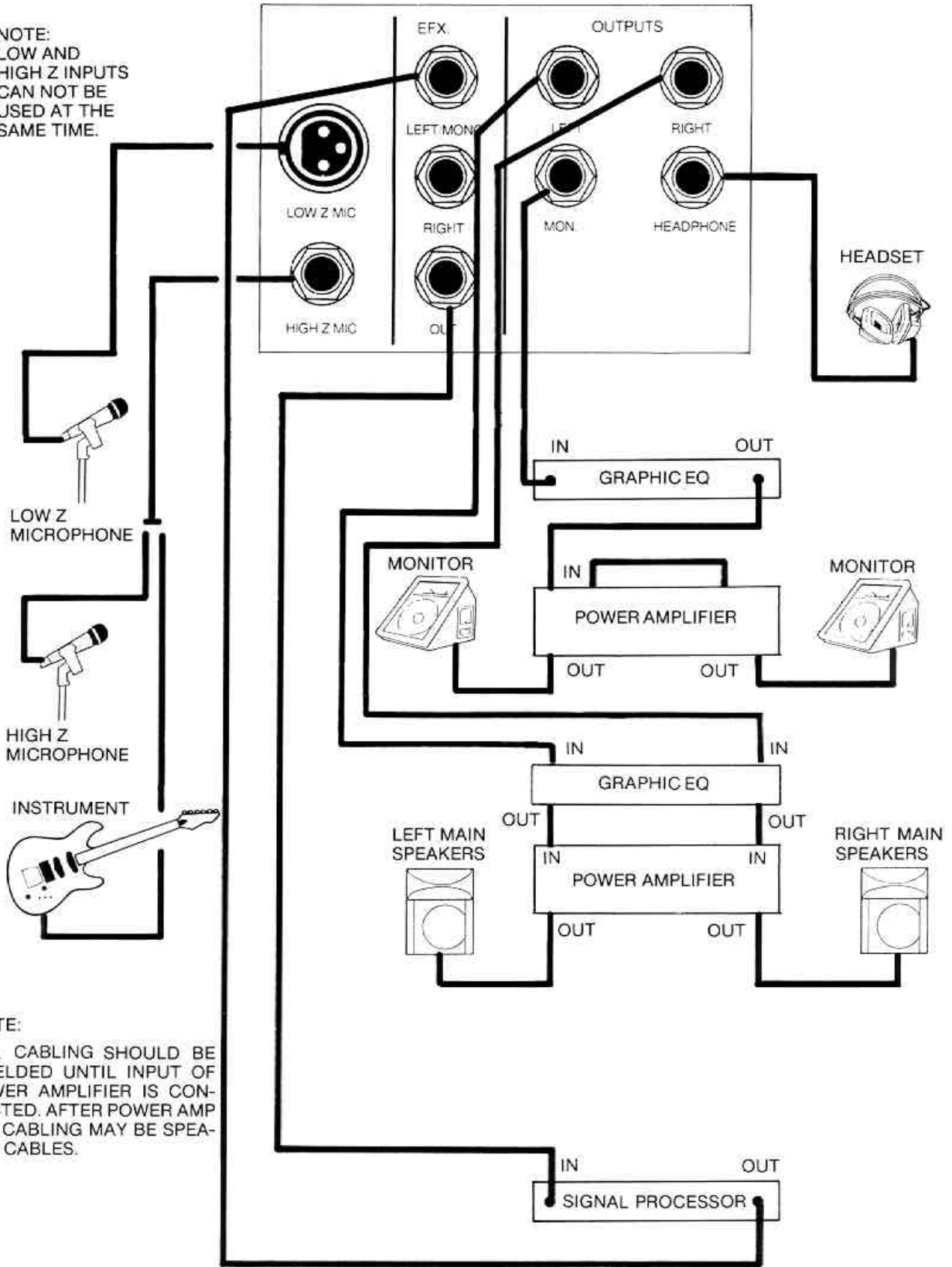

NOTE:
ALL CABLING SHOULD BE
SHIELDED UNTIL INPUT OF
POWER AMPLIFIER IS CON-
NECTED. AFTER POWER AMP
ALL CABLING MAY BE SPEA-
KER CABLES.

NOTE: THE SIGNAL PROCESSOR PATCH IS IN MONO.
(SEE STEREO PATCH)

STEREO EFFECTS PATCH

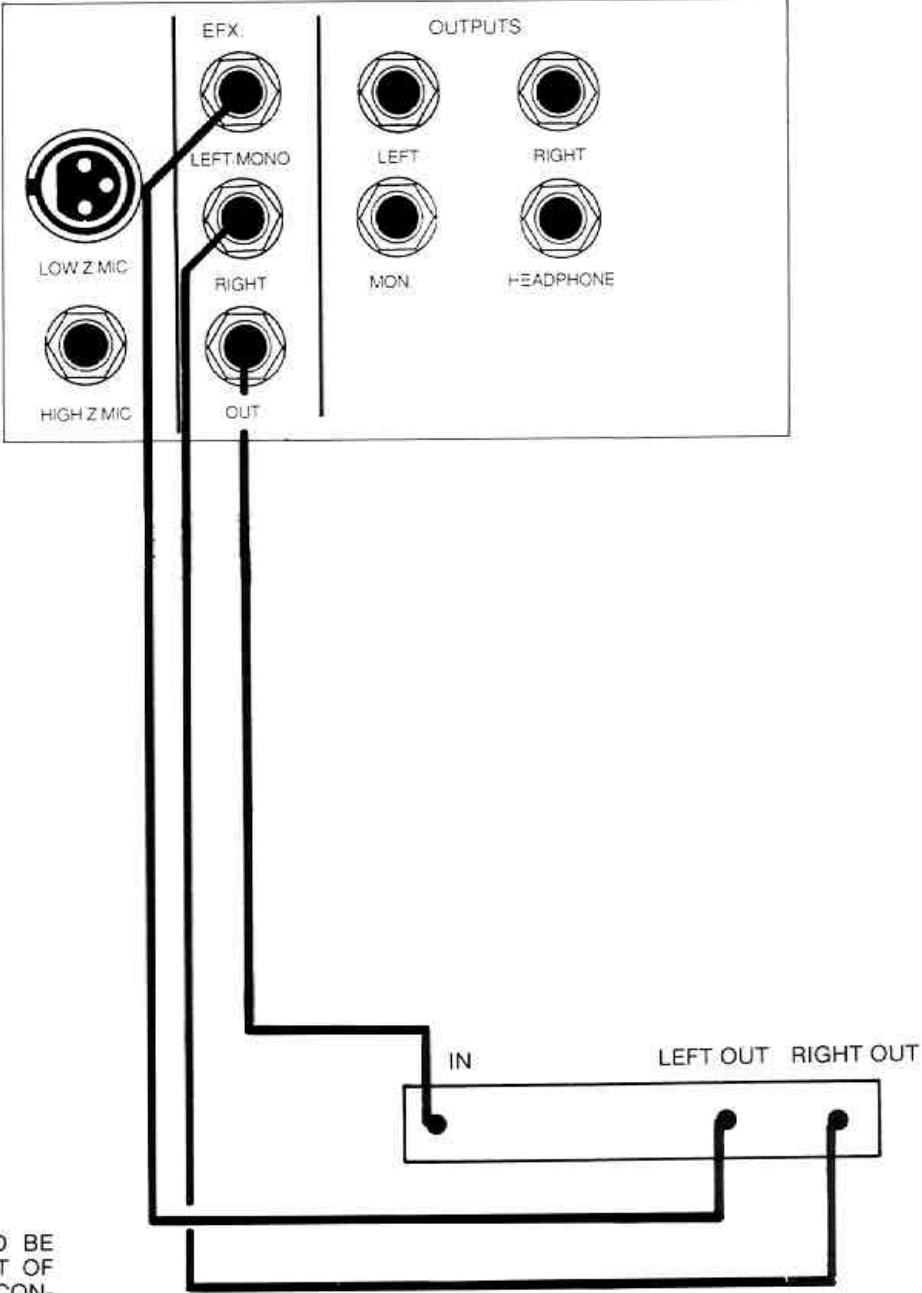

NOTE:
ALL CABLING SHOULD BE SHIELDED UNTIL INPUT OF POWER AMPLIFIER IS CONNECTED. AFTER POWER AMP ALL CABLING MAY BE SPEAKER CABLES.

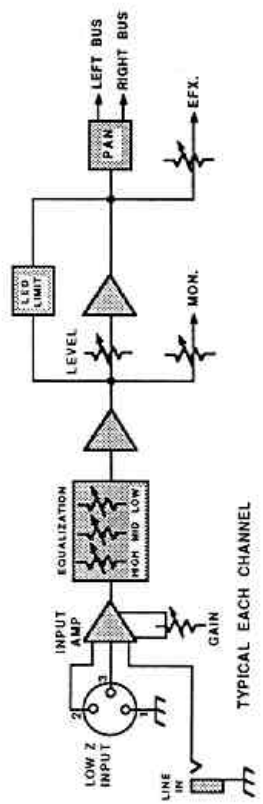

TYPICAL EACH CHANNEL

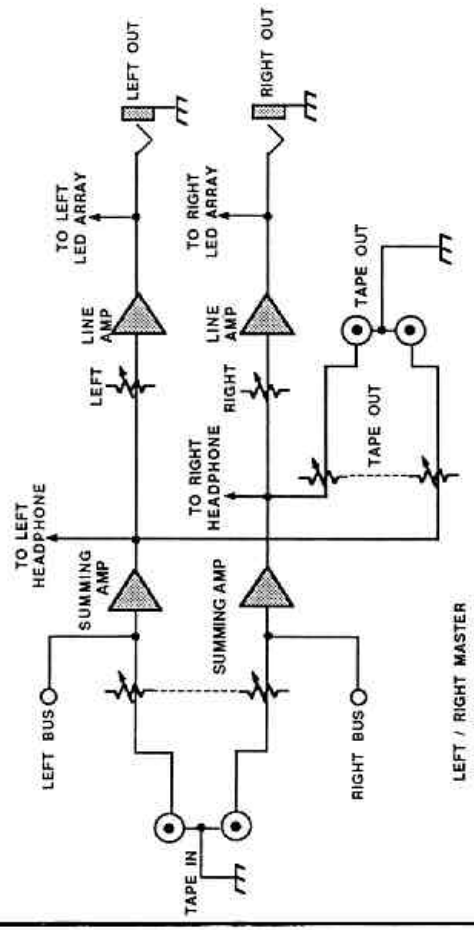

LEFT / RIGHT MASTER

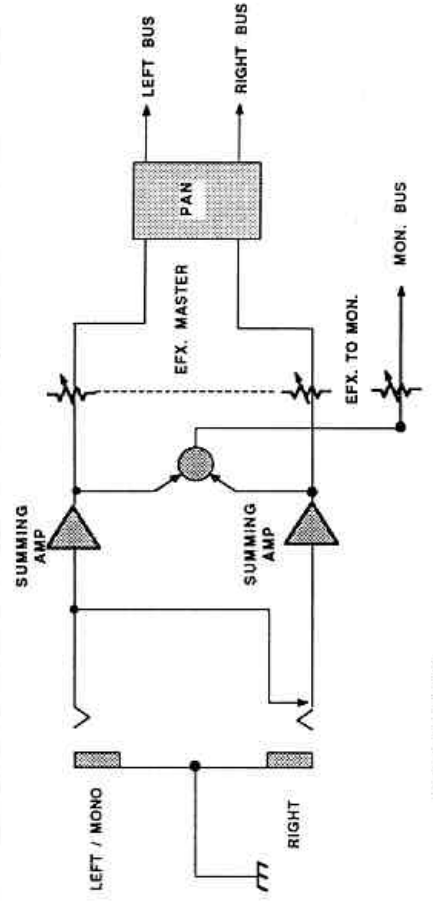

EFX A-B MASTER

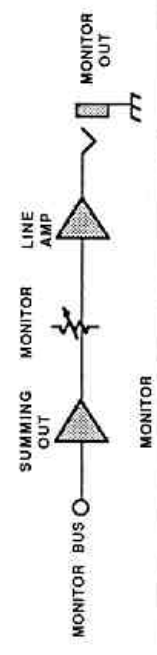

MONITOR

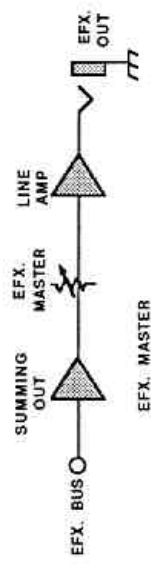

EFX. MASTER

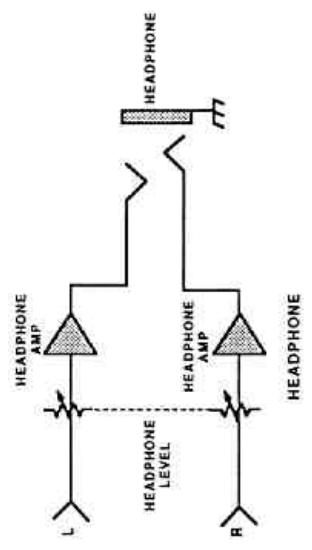

HEADPHONE

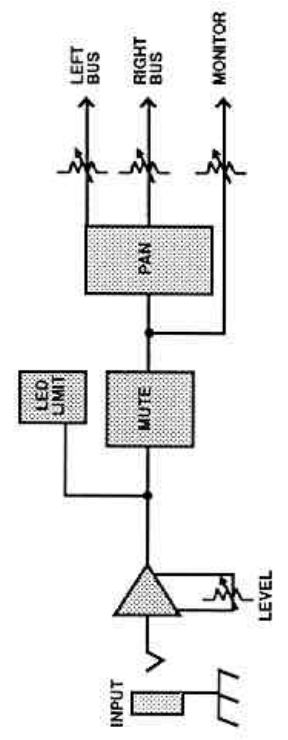

TYPICAL EACH SUB MIX CHANNEL

UNITY™ 1000 SM

THIS LIMITED WARRANTY VALID ONLY WHEN PURCHASED AND REGISTERED IN THE UNITED STATES OR CANADA. ALL EXPORTED PRODUCTS ARE SUBJECT TO WARRANTY AND SERVICES TO BE SPECIFIED AND PROVIDED BY THE AUTHORIZED DISTRIBUTOR FOR EACH COUNTRY.

Ces clauses de garantie ne sont valables qu'aux Etats-Unis et au Canada. Dans tous les autres pays, les clauses de garantie et de maintenance sont fixées par le distributeur national et assurées par lui selon la législation en vigueur.

Diese Garantie ist nur in den USA und Kanada gültig. Alle Export-Produkte sind der Garantie und dem Service des Importeurs des jeweiligen Landes unterworfen.

Esta garantía es válida solamente cuando el producto es comprado en E.U. continentales o en Canada. Todos los productos que sean comprados en el extranjero, están sujetos a las garantías y servicio que cada distribuidor autorizado determine y ofrezca en los diferentes países.

ONE-YEAR LIMITED WARRANTY/REMEDY

PEAVEY ELECTRONICS CORPORATION ("PEAVEY") warrants this product, EXCEPT for covers, footswitches, patchcords, tubes and meters, to be free from defects in material and workmanship for a period of one (1) year from date of purchase, PROVIDED, however that this limited warranty is extended only to the original retail purchaser and is subject to the conditions, exclusions and limitations hereinafter set forth:

PEAVEY 90-DAY LIMITED WARRANTY ON TUBES AND METERS

If this product contains tubes or meters, Peavey warrants the tubes or meters contained in the product to be free from defects in material and workmanship for a period of ninety (90) days from date of purchase; PROVIDED, however, that this limited warranty is extended only to the original retail purchaser and is also subject to the conditions, exclusions and limitations hereinafter set forth.

CONDITIONS, EXCLUSIONS AND LIMITATIONS OF LIMITED WARRANTIES

These limited warranties shall be void and of no effect if:

- a. The first purchase of the product is for the purpose of resale; or
- b. The original retail purchase is not made from an AUTHORIZED PEAVEY DEALER; or
- c. The product has been damaged by accident or unreasonable use, neglect, improper service or maintenance, or other causes not arising out of defects in material or workmanship; or
- d. The serial number affixed to the product is altered, defaced or removed.

In the event of a defect in material and/or workmanship covered by this limited warranty, Peavey will:

- a. In the case of tubes or meters, replace the defective component without charge;
 - b. In the other covered cases (i.e., cases involving anything other than covers, footswitches, patchcords, tubes or meters), repair the defect in material or workmanship or replace the product, at Peavey's option;
- and provided, however, that, in any case, all costs of shipping, if necessary, are paid by you, the purchaser.

THE WARRANTY REGISTRATION CARD SHOULD BE ACCURATELY COMPLETED AND MAILED TO AND RECEIVED BY PEAVEY WITHIN FOURTEEN (14) DAYS FROM THE DATE OF YOUR PURCHASE.

In order to obtain service under these warranties, you must:

- a. Bring the defective item to any AUTHORIZED PEAVEY DEALER or AUTHORIZED PEAVEY SERVICE CENTER and present therewith the ORIGINAL PROOF OF PURCHASE supplied to you by the AUTHORIZED PEAVEY DEALER in connection with your purchase from him of this product. If the DEALER or SERVICE CENTER is unable to provide the necessary warranty service you will be directed to the nearest other PEAVEY AUTHORIZED DEALER or AUTHORIZED PEAVEY SERVICE CENTER which can provide such service.

OR

- b. Ship the defective item, prepaid, to:

PEAVEY ELECTRONICS CORPORATION
International Service Center
Highway 80 East
MERIDIAN, MS 39301

including therewith a complete, detailed description of the problem, together with a legible copy of the original PROOF OF PURCHASE and a complete return address. Upon Peavey's receipt of these items:

If the defect is remedial under these limited warranties and the other terms and conditions expressed herein have been complied with, Peavey will provide the necessary warranty service to repair or replace the product and will return it, FREIGHT COLLECT, to you, the purchaser.

Peavey's liability to the purchaser for damages from any cause whatsoever and regardless of the form of action, including negligence, is limited to the actual damages up to the greater of \$500.00 or an amount equal to the purchase price of the product that caused the damage or that is the subject of or is directly related to the cause of action. Such purchase price will be that in effect for the specific product when the cause of action arose. This limitation of liability will not apply to claims for personal injury or damage to real property or tangible personal property allegedly caused by Peavey's negligence. Peavey does not assume liability for personal injury or property damage arising out of or caused by a non-Peavey alteration or attachment, nor does Peavey assume any responsibility for damage to interconnected non-Peavey equipment that may result from the normal functioning and maintenance of the Peavey equipment.

UNDER NO CIRCUMSTANCES WILL PEAVEY BE LIABLE FOR ANY LOST PROFITS, LOST SAVINGS, ANY INCIDENTAL DAMAGES OR ANY CONSEQUENTIAL DAMAGES ARISING OUT OF THE USE OR INABILITY TO USE THE PRODUCT, EVEN IF PEAVEY HAS BEEN ADVISED OF THE POSSIBILITY OF SUCH DAMAGES.

THESE LIMITED WARRANTIES ARE IN LIEU OF ANY AND ALL WARRANTIES, EXPRESS OR IMPLIED, INCLUDING, BUT NOT LIMITED TO, THE IMPLIED WARRANTIES OF MERCHANTABILITY AND FITNESS FOR A PARTICULAR USE; PROVIDED, HOWEVER, THAT IF THE OTHER TERMS AND CONDITIONS NECESSARY TO THE EXISTENCE OF THE EXPRESS, LIMITED WARRANTIES, AS HEREINABOVE STATED, HAVE BEEN COMPLIED WITH, IMPLIED WARRANTIES ARE NOT DISCLAIMED DURING THE APPLICABLE ONE-YEAR OR NINETY-DAY PERIOD FROM DATE OF PURCHASE OF THIS PRODUCT.

SOME STATES DO NOT ALLOW LIMITATION ON HOW LONG AN IMPLIED WARRANTY LASTS, OR THE EXCLUSION OR LIMITATION OF INCIDENTAL OR CONSEQUENTIAL DAMAGES, SO THE ABOVE LIMITATIONS OR EXCLUSIONS MAY NOT APPLY TO YOU. THESE LIMITED WARRANTIES GIVE YOU SPECIFIC LEGAL RIGHTS, AND YOU MAY ALSO HAVE OTHER RIGHTS WHICH MAY VARY FROM STATE TO STATE.

THESE LIMITED WARRANTIES ARE THE ONLY EXPRESS WARRANTIES ON THIS PRODUCT, AND NO OTHER STATEMENT, REPRESENTATION, WARRANTY OR AGREEMENT BY ANY PERSON SHALL BE VALID OR BINDING UPON PEAVEY.

In the event of any modification or disclaimer of express or implied warranties, or any limitation of remedies, contained herein conflicts with applicable law, then such modification, disclaimer or limitation, as the case may be, shall be deemed to be modified to the extent necessary to comply with such law.

Your remedies for breach of these warranties are limited to those remedies provided herein and Peavey Electronics Corporation gives this limited warranty only with respect to equipment purchased in the United States of America.

INSTRUCTIONS — WARRANTY REGISTRATION CARD

1. Mail the completed WARRANTY REGISTRATION CARD to:

PEAVEY ELECTRONICS CORPORATION
POST OFFICE BOX 2898
MERIDIAN, MISSISSIPPI 39302-2898

- a. Keep the PROOF OF PURCHASE. In the event warranty service is required during the warranty period, you will need this document. **There will be no identification card issued by Peavey Electronics Corporation.**
2. IMPORTANCE OF WARRANTY REGISTRATION CARDS AND NOTIFICATION OF CHANGES OF ADDRESS:
 - a. Completion and mailing of WARRANTY REGISTRATION CARDS — Should notification become necessary for any condition that may require correction, the REGISTRATION CARD will help ensure that you are contacted and properly notified.
 - b. Notice of address changes — If you move from the address shown on the WARRANTY REGISTRATION CARD, you should notify Peavey of the change of address so as to facilitate your receipt of any bulletins or other forms of notification which may become necessary in connection with any condition that may require dissemination of information or correction.
3. You may contact Peavey directly by telephoning (601) 483-5365.
4. Please have the Peavey product name and serial number available when communicating with Peavey Customer Service.



Features and specifications subject to change without notice.

Peavey Electronics Corporation 711 A Street / Meridian, MS 39302-2898 / U.S.A. / (601) 483-5365 / Telex: 504115 / Fax: 484-4278